

Recc all piping to be sized per ASHRAE F36

Note: This drawing shows suggested piping configuration. Check with local codes and ordinances for additional requirements.

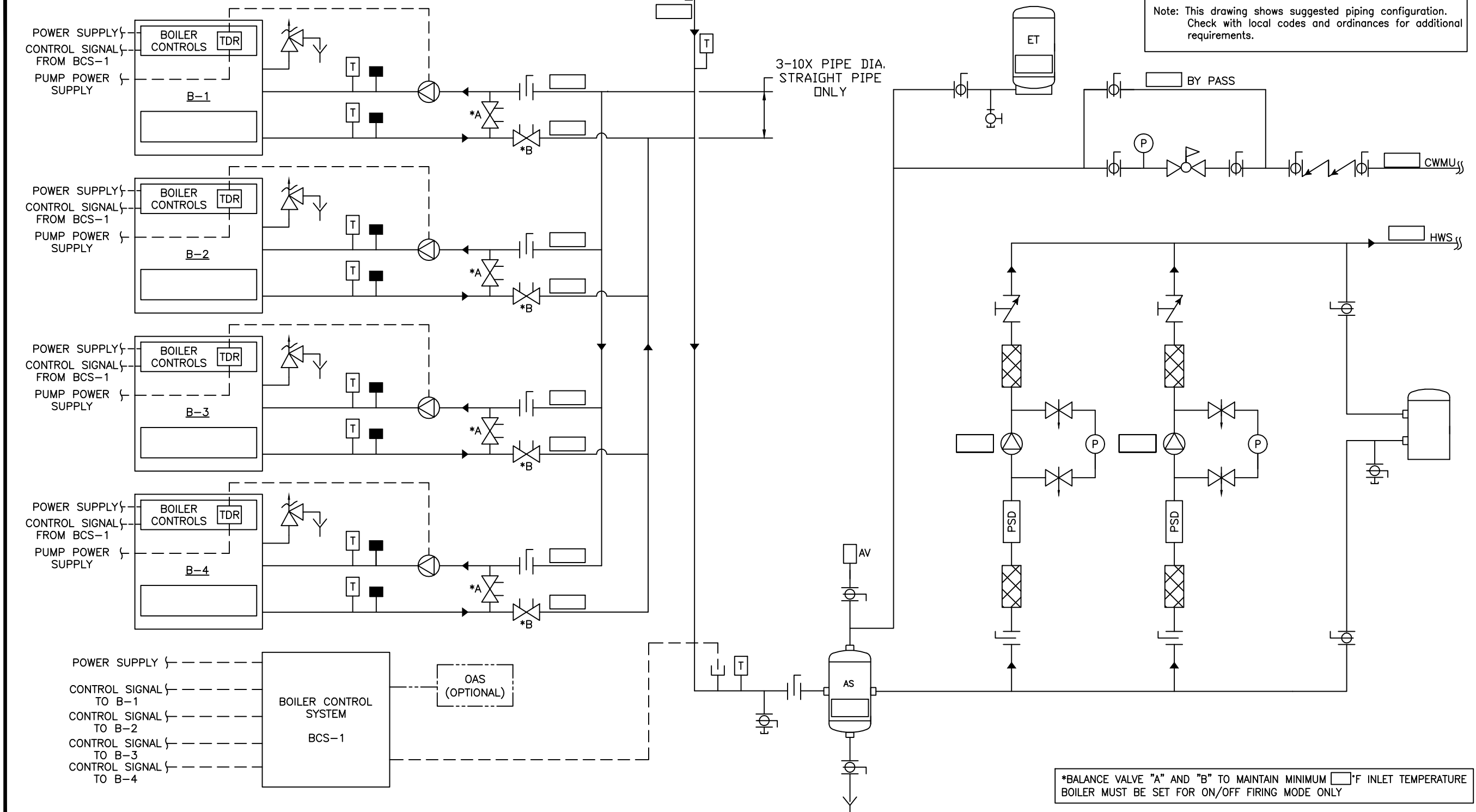

REV	DESCRIPTION	BY	DATE
A	RELEASED	RSG	05/28/08

THIS DRAWING AND THE INFORMATION DEPICTED THEREIN IS THE PROPERTY OF CHC, CALIFORNIA HYDRONICS CORP. COPIES ARE ISSUED IN STRICT CONFIDENCE AND SHALL NOT BE REPRODUCED OR COPIED, OR USED AS THE BASIS FOR THE MANUFACTURING, INSTALLATION OR SALE OF PRODUCT WITHOUT PRIOR WRITTEN PERMISSION OF CHC.

PROJECT NAME:
PROJECT LOCATION:
ENGINEER:
CUSTOMER:

DRAWING TITLE:
HYDRONIC PRIMARY/SECONDARY - 4 ATMOSPHERIC BOILERS WITH SEPARATE PRIMARY PUMP POWER, CIRCUIT SETTER PROTECTION, WITH 2 SYSTEM PUMPS

DRAWING No. H-PS-101-4CS-2
REV A

TOLERANCES UNLESS OTHERWISE SPECIFIED
DRAWN BY DATE: D.K. 05/23/08
CHECKED APPROVED DEC. ANGLE 5" SIZE D SCALE NTS

